

FLIGHT READINESS REVIEW TO THE NASA 2011  
UNIVERSITY STUDENT LAUNCH INITIATIVE

A Study of Atmospheric Properties as a  
Function of Altitude

*By*  
HARDING FLYING BISON  
2011 USLI ROCKET TEAM

MARCH 26, 2011

## Table of Contents

1.	Summary of FRR Report -----	2
	a. Team Summary	2
	b. Launch Vehicle Summary	2
	c. Payload Summary	2
2.	Changes made since CDR -----	3
	a. Vehicle Changes	3
	b. Payload Changes	3
	c. Activity Plan Changes	3
3.	Vehicle Criteria -----	4
	a. Testing and Design of Launch Vehicle	4
	b. Recovery Subsystem	7
	c. Mission Performance Predictions	9
	d. Safety and Environment (Vehicle)	12
	e. Payload Integration	14
4.	Payload Criteria -----	16
	a. Experiment Concept	16
	b. Science Value	17
	c. Experiment Design of Payload	18
	d. Payload Assembly	20
	e. Safety and Environment (Payload)	20
5.	Launch Operation Procedures -----	22
	a. Checklist	22
	b. Safety and Quality Assurance	24
6.	Activity Plan -----	25
	a. Budget Plan	25
	b. Timeline	25
	c. Educational Engagement	26
7.	Conclusion -----	27
8.	Appendix -----	28
	a. Motor Preparation Manual	28

## **1. Summary of FRR Report**

### **1.a Team summary**

We are the Harding University Flying Bison Rocket team. The University is located at 915 East Market Street, Searcy, Arkansas. Our mentor and team official is Dr. Edmond Wilson.

### **1.b Launch Vehicle Summary**

#### **1.b.1 Vehicle size**

This year we will be flying a six inch diameter rocket. The rocket will be 110 inches in length, and 643 ounces. We will use a pre-glassed phenolic airframe. The added weight will be offset by a more powerful motor. We will use an aft section that is 42 inches in length, a drogue section that is 15 inches in length, and a main section that is 28 inches in length.

#### **1.b.2 Final motor choice**

We have selected to use the 75mm L-1222 hybrid motor from Conrail Rocket. We chose to fly a hybrid motor because they are safe to handle and because the University conducts research on hybrid motor emissions. The L-1222 has a length of 52.75 inches and a weight of 175.982 ounces. It burns for 3.1 seconds with a total impulse of 3693.88 Newton-seconds. The maximum thrust is 2689 Newtons.

#### **1.b.3 Recovery system**

We will deploy a 44" SkyAngle drogue parachute at apogee. We will deploy the 120" conical parachute from Public Missiles main chute at 800 feet. The rocket will descend approximately 66 ft/s and 20 ft/s under drogue and main respectively. We will use two PerfectFlight mini Altimeters to deploy the parachutes. We will separate our payload from the nosecone at 2500 feet using the Co-Pilot Version 2.0 Altimeter. After the rocket has landed, we will use the Walston retrieval system to track its position.

#### **1.b.4 Rail size**

The launch rail extends seven feet up and can be rotated to fire at many angles from the horizon. The rail is 1 square inch with a .25 inch slot.

### **1.c Payload Summary**

We are integrating the payload suggested by the Science Mission Directorate. We will take data for the temperature, humidity, pressure, solar irradiance, and ultraviolet radiation during descent and after landing. We will also take three pictures during descent and three pictures after the payload has landed. We intend to separate the payload from the airframe at 2,500 feet. The payload will also have a GPS system and a separate altimeter.

## **2. Changes Made Since CDR**

### **2.a Vehicle Changes**

Since the CDR, very few changes have been made to the vehicle design. The motor mount tube was originally designed to be 36 inches long but has now been changed to 30 inches. This was the result of a problem during the rocket fabrication. The centering ring towards the front of the rocket was left at the original location, but it is not longer connected to the motor mount. All other sections were constructed as designed in the CDR.

### **2.b Payload Changes**

The payload function has not been changed since the CDR. The sensors chosen are adequate based on the current test results, and the microprocessor is able to handle all of the requirements. The structure of the payload is also unchanged with the exception of material choices. The base plate will now be made of fiberglass while the hinges of the legs are made of the same ABS plastic that the legs are made of.

### **2.c Activity Plan Changes**

We have added events to the activity plan since the CDR. Four members of the rocket team will be speaking at the 2011 Arkansas Undergraduate Rocket Convention. Members of the team will also present the year's work at the Arkansas Space Grant Consortium event on April 22. The rocket team has been in close contact sponsoring a local high school team with the BalloonSAT project. The outreach program has set final dates for all of the events to happen this year.

### 3. Vehicle Criteria

#### 3.a Testing and Design of Launch Vehicle

##### 3.a.1 Material usage

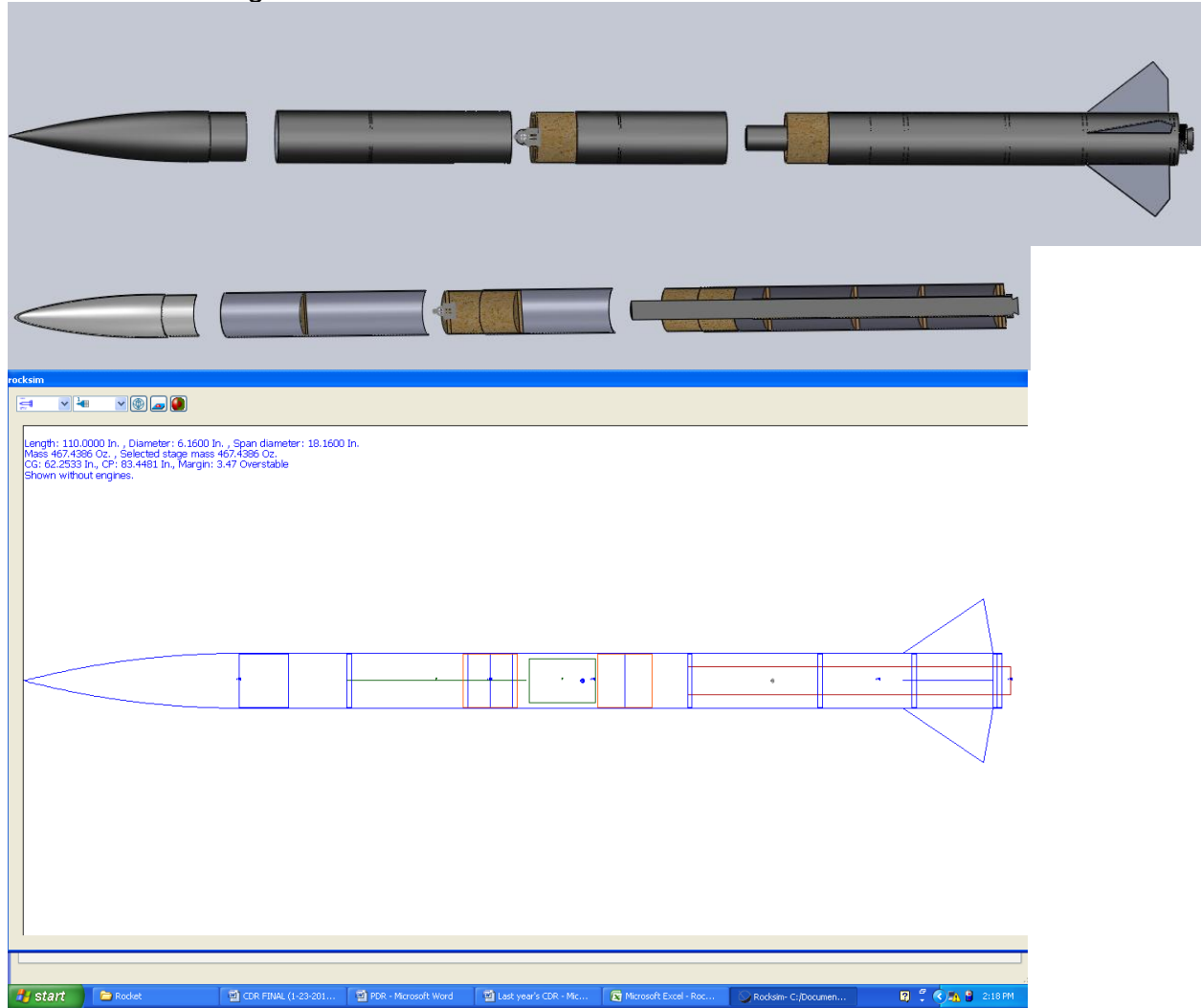

Using proper materials during construction is critical to ensuring reliable performance of the rocket. The figures above are schematics of the Harding rocket without airframe and coupler tubes shown. The airframe consists of the following components:

- Motor Retention System
- Fins
- Airframe Tube
- Avionics Bay
- Nose Cone

A description of these components will be further discussed below.

##### Motor Retention System

An Aero Pack, Inc. Quick Change Motor Retainer Model RA75 Assembly was selected for the Conrail 75 mm hybrid rocket motor casing. It is milled from solid 6061-T6 aluminum bar stock with Mil-Spec Type II Black Anodizing and mates perfectly with the phenolic motor tube. The retainer is mounted directly to the centering ring and prevents the motor from backing out of the airframe during flight. Everything can be assembled by hand without any tools once the original installation takes place.

The motor mount tube is Kraft phenolic tubing purchased from Public Missiles. It has a compressive strength five times larger than cardboard tubing. The tube has an inner diameter of 3.002 in.

The centering rings, Public Missiles CR-6.0-3.0, are constructed from 9-ply 1/2" birch plywood. Five centering rings are employed in the motor retention system. Due to errors in construction, the centering rings are not evenly spaced across the motor mount tube. Six centering rings are utilized such that the motor is sufficiently aligned when inserted into the airframe. The spacing of the centering rings can be seen in the figures above.

### Fins

The fins are composed of 0.093 in. thick G-10 fiberglass laminate, style FIN-C-07 purchased from Public Missiles. Their dimensions are shown in the following figure. G-10 is made of continuous woven fiberglass impregnated with epoxy resin. It has a density of 1.8 g/cm<sup>3</sup> with excellent structural properties, as shown in Table 1. Each fin was mounted with epoxy to the motor mount tube through slots in the airframe.

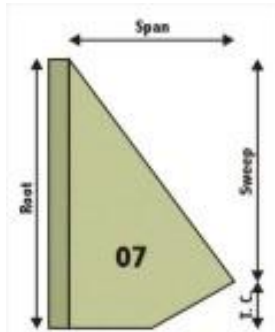

Tensile Strength	38,000 PSI	Compressive Strength	66,000 PSI
Flexural Strength	60,000 PSI	Shear Strength	21,500 PSI
Maximum Temperature	140 °C	Coefficient of Thermal Expansion	1 x 10 <sup>-5</sup> in/in/°C

## Airframe Tube

The airframe tubing is commercially produced by Public Missiles and is comprised of pre-glassed phenolic with a fiberglass wrapping. The airframe has an inner diameter of 6.007 in. This body style was selected due to its high strength. The selected motor allows for the added weight.

The coupler tube is made from the same Kraft phenolic as the motor mount tube and has an inner diameter of 5.86 in. It is attached with epoxy resin glue to the middle section of the airframe. The aft end of the coupler tube is friction fit by adding masking tape to “snug up” the fit. Three plastic rivets at 120° intervals are added to this end to help insure the coupler does not separate before the ejection charge blows these two sections of the airframe apart.

## Avionics Bay

The avionics bay was mounted inside a 12 in. long section of Kraft phenolic coupler tubing with a 3/8 in. thick birch plywood bulk plate enclosing the instrumentation at one end and another bulkplate affixed halfway through the coupler tube. The avionics bay utilizes 6.25 inches of the coupler section and the other area of the coupler is used to encase the drogue parachute. This arrangement served the two-fold purpose of providing a rugged housing for the science payload and a robust coupler to couple the forward and aft sections of the rocket together. Two - 1/4 in. x 20 tpi lengths of all-thread fitted with washers and nuts secured the two bulk plates tightly against the Avionics Bay in the coupler tube.

## Nose Cone

A fiberglass nose cone with a diameter of 6.007 in. (model FNC-6.0 from Public Missiles) was selected. Fiberglass nose cones are convenient because they are strong, light, and easy to finish. The nose cone is attached to the airframe with plastic shear pins to allow for simple separation during descent.

### 3.a.2 Selection rationale

See section 3.a.1 above for selection rationale

### 3.a.3 Strength of assembly

We believe that our rocket was designed with a high strength of assembly. All materials were chosen with a high factor of safety. Each coupler, fin, centering ring, and the motor mount were affixed using epoxy. Coupler sections were designed to have ample surface area with the connecting airframe tubing. The launch lugs were affixed to the rocket with screws. The lugs were lined up using a straight end and level. The lugs have been tested for proper strength and location. The airframe is connected with shock cord that is tied to U-bolts at the end of each rocket section. The strength of the shock cord and U-bolts has been previously tested using the INSTRON tensile testing machine.

The motor tube was fastened in the rocket with six centering rings. The motor mount was bolted into the back of the rocket with 16 bolts. The back of the retainer is unscrewed to insert the motor and is then replaced.

#### 3.a.4 Integrity of design

See section 3.a.2 to review the integrity of design.

#### 3.a.5 Approach to workmanship

The team mentor works with the students during the construction process and teaches proper shop skills and methods for a quality product, terms of safety, appearance and robustness. Careful detail regarding workmanship is crucial to the success of the mission, and minute flaws in construction could potentially lead to catastrophic failure. When construction is carefully executed, there is a higher probability of success, and the final product will be more attractive.

#### 3.a.6 Safety and failure analysis

Rocket analysis of failure modes including proposed and completed mitigations:

The rocket will be the most robust vehicle that we have produced. The failures experienced with previous similar rockets were:

- The airframe might slip apart before the ejection charges are fired. We are using plastic shear pins to minimize this possibility.
- The ejection charges for the drogue forced the airframe apart releasing the main parachute at apogee. The shear pins we are using should prevent this from happening.
- The parachute deployed during maximum thrust by the rocket motor, ripping the parachute from the airframe and causing total loss of rocket and payload. Our present design should not cause pressure changes that mislead the flight computers into thinking apogee had been reached prematurely.
- A fin became unglued upon landing impact. We are going to reinforce the fin to motor mount attachment with fiberglass and epoxy.
- Eyebolts may fail if the force exceeds 600 lbf. Heavier eyebolts will be chosen, if necessary, to avoid this situation.

#### 3.a.7 Full scale test results

Because of delays associated with the delivery by the supplier of the rocket components, we were not able to begin construction of the rocket until after our Spring Break. We have completed major construction as of March 27, 2011 and will test fly on April 9, 2011.

### **3.b Recovery Subsystem**

#### 3.b.1 Parachute details

We will deploy a 44" SkyAngle drogue parachute at apogee. We will deploy the 120" conical parachute from Public Missiles main chute at 800 feet. The rocket will descend



approximately 66 ft/s and 20 ft/s under drogue and main respectively. We will use two PerfectFlight mini Altimeters to deploy the parachutes. We will separate our payload from the nosecone at 2500 feet using the Co-Pilot Version 2.0 Altimeter. Each parachute is attached to a D-ring that is connected to a knot in the shock cord. The shock cords are connected to U-bolts on each bulk plate. The drogue parachute is attached to the motor and the avionics section and will be separated with redundant black powder charges at apogee. The main parachute will be attached to the avionics section and the bulk plate at the forward of the main section.

### 3.b.2 Safety and failure analysis

<b>Concern</b>	<b>Analysis</b>
Early deployment of drogue	This is a problem that we have faced in the past. The parachutes were deployed at maximum thrust and the airframe failed catastrophically. We will combat this problem by testing our altimeters regularly.
Deployment of main at apogee	This is also a problem that we have faced in the past. There is no safety risk, but an early main deployment will cause the rocket to drift out of its intended landing zone. We will ensure this will not happen by adding shear pins to the connection of the avionics section with the main section.
No deployment of drogue	This is failure that concerns us the most. A rocket that has gone ballistic is obviously a major safety concern. We have never had a problem with this, but we continue to test our altimeters and we always use at least two altimeters with back-up charges.
No deployment of main	This is a concern for the completion of our competition goals. Although this failure would not be as dangerous, it still produces an unsafe situation to bystanders. It would also lead to a much more forceful impact of the rocket with the ground. This could cause damage to the airframe and the flight computers.
Separation of parachute from rocket	We are aware that it is a possibility that the parachute could become separated from the shock cord or the the shock cord could become separated from the rocket. We ensure they will stay together by using shock cord with a high factor of safety and knots that are intended to be used for high powered rocketry. Our connection hardware is also tested to a high factor of safety. We have tested all of these components with a tensile testing machine in the engineering laboratory.
Rocket damage during descent	A common problem we have found is airframe “zippering” and airframe damage due to mid-air collisions of the airframe. We mitigate the mid-air collisions by measuring our shock cord so that each piece of the airframe will hang down a different amount from the parachutes. We

	tackle the “zippering” affect by placing our charges on the side of the parachute this is pushed out of the airframe.
--	---

### 3.c Mission Performance Predictions

#### 3.c.1 Mission performance criteria

The mission will be a success if the following objectives are met:

##### Pre-Launch

- Complete assembly
- Electronics activated and responsive
- Full battery Charge
- Establish RF connection
- Proper Motor preparation

##### Launch

- Motor Ignition
- Rocket successfully leaves launch pad
- Correct thrust to weight ratio
- Stable flight by guidance rail
- Stabilization by fins
- Maintains integrity despite (LAUNCH) forces
- Motor burns completely

##### Flight

- Barometric system locked
- Thrust launches rocket to 5280 feet altitude
- Apogee reached
- Gauged by accelerometers/barometer
- Drogue parachute launched
- Rocket successfully separate
- Drogue Parachute Successfully deploy
- Rocket begins descent
- Barometer detects altitude of 800 feet
- Main parachute deploys
- Rocket successfully separates again
- Main parachute successfully deploys
- Rocket decelerates to 17 feet per second
- Rocket Lands

##### Recovery

- Power maintained throughout flight
- GPS sends coordinates
- Rocket recovered
- Data retrieved within 30 minute window
- Integrity
- Airframe integrity maintained
- Electronics functionality maintained
- Rocket remains in reusable condition

### Major Reports

- Proposal submitted on time
- Web Site Active
- PDR submitted on time
- CDR submitted on time
- FRR submitted on time
- Final Report submitted on time

### Safety and Environment

- No injuries to life forms
- Environment not affected

#### 3.c.2 Flight profile simulations

See section 3.c.4 for the profile simulations.

#### 3.c.3 Analysis validity

We have found our RockSIM simulations to be valid in the past, and we expect them to be valid once again. We still plan to conduct wind tunnel testing on a scale model of our rocket.

#### 3.c.4 Stability margin

The stability margin is 2.49. The CP is located at 68.2 inches from the front of the rocket and the CG is located at 83.4 inches from the front of the rocket.

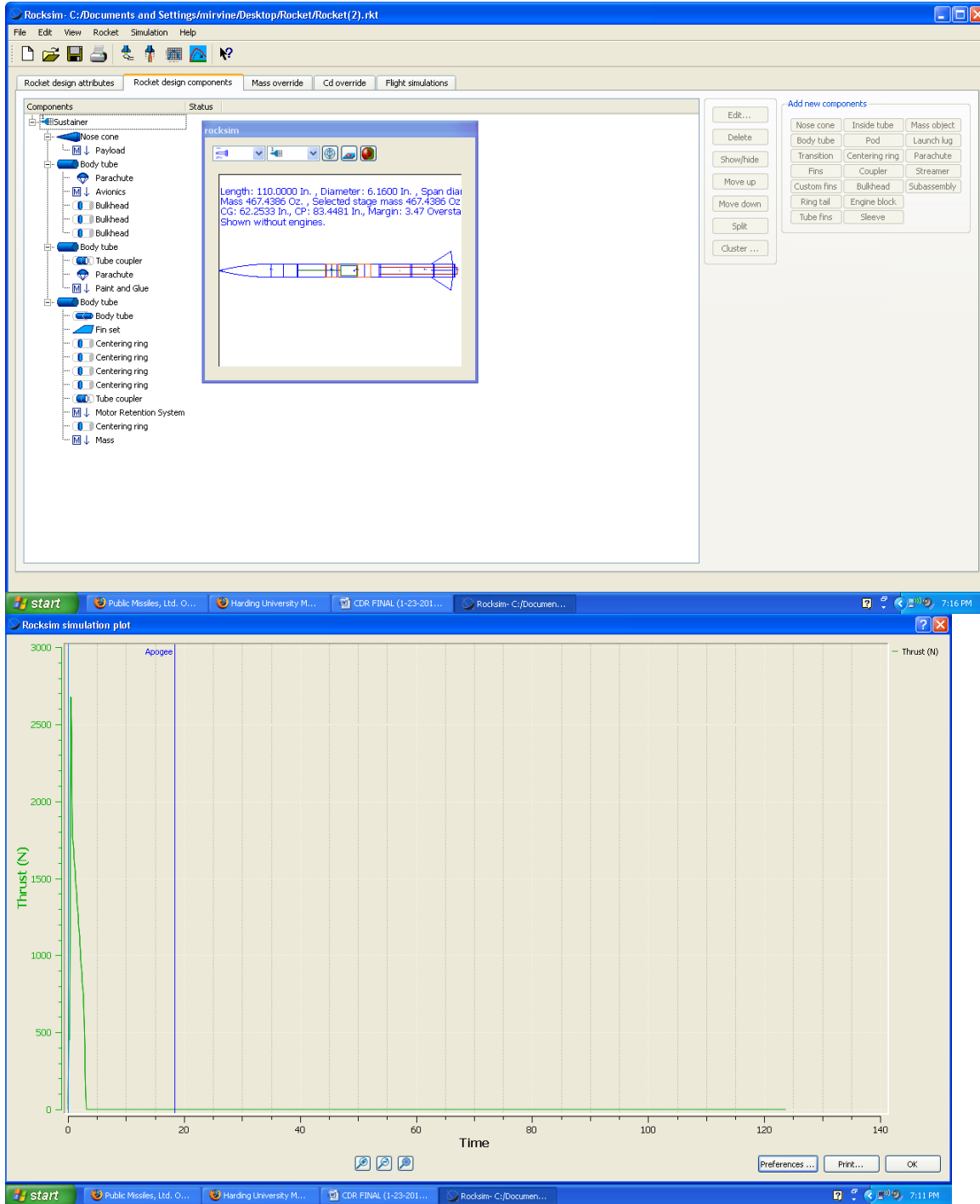

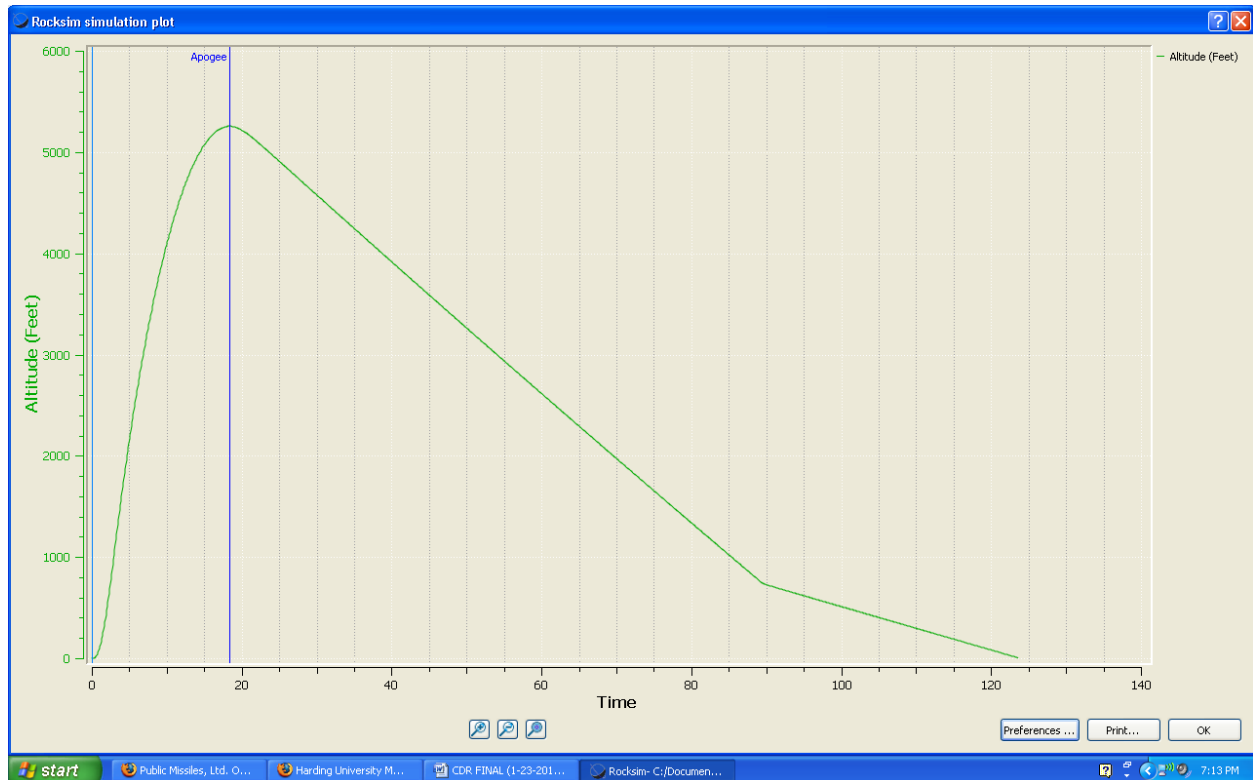

### 3.d Safety and Environment (Vehicle)

#### 3.d.1 Safety officer

Edmond Wilson, Team Official, is the Safety Officer for the Harding Flying Bison 2010 USLI Rocket Team. He holds a NAR Level 2 Certification. Edmond Wilson's NAR Member Number is 86424.

#### 3.d.2 Updated failure mode analysis

Airframe:

- Airframe fails to hold motor in place causing motor to tear through the airframe.
- We will reinforce the hardware which holds the motor casing thrust ring in place.
- Motor falls backwards out of motor housing tube during flight. We will use a commercial motor retainer to prevent this failure.
- The airframe fails to separate when separation charges ignite. We will sand down the junctions properly to ensure that they are loose enough to separate but still tight enough to hold together during flight.
- Fins become separated or tear through the airframe upon hard landing. We will reinforce attachment of the fins to the airframe and to the motor housing tube with Kevlar or nylon using epoxy adhesive.
- Shock cords separate when deployed. We have perform tensile strength measurements on the shock cords to pick the minimum size cord that will be strong enough and increase the size to twice tensile strength specified.

- The primary flight computer malfunctions. We have a second flight computer that will provide the same functions and sensors to the rocket as the primary, which we can use in the case of any damage or malfunction to the primary computer.

#### Payload:

- Batteries will fail during launch. We will install brand new fresh batteries as part of the rocket preparation. Each electronic system will have its own battery supply. We also will bring extra charged batteries to the launch site.
- Circuit boards and batteries break off their mounting boards and devices at launch. We will pay special attention to making these mounting boards and battery holders as strong and solid as possible.
- Cables detach during pre-launch or launch. We will reinforce the connections with tape to prevent separation.

#### Launch Operations:

- Five hundred foot cable connecting rocket ignition box at the rocket launch pad with the operator controls fails. We can test the connectivity prior to launch and correct any problems.
- Battery failure in operator control box. We will bring a back-up battery and make sure the original battery is charged and tested just before launch.
- Nitrous oxide cylinder too warm or too cold producing pressures below 600 psi or greater than 900 psi. We will keep the nitrous in a thermal container that can be filled with either ice water or hot water to adjust the temperature. In April one usually needs to cool the nitrous cylinder.

#### 3.d.3 Updated personnel hazards

- Exposure of skin and eyes to epoxy resins – Exposure of hands to epoxy adhesive materials will be minimized by the use of protective eyewear and gloves.
- Exposure of skin and eyes to fiberglass fibers and Kevlar™ fibers – Exposure of hands to fiberglass fibers and Kevlar™ fibers will be minimized by the use of protective eyewear and gloves.
- Exposure of eyes and lungs to acrylic spray paint – All painting will be done with doors to shop opened and vent fan on. Protective eyewear and a mask covering nostrils and mouth will be worn.
- Trauma to body from improper use of hand tools – Proper use of hand tools will be explained as needed for each process undertaken.
- Trauma to body from improper use of metalworking machines – All team members will wear protective eyewear, and instruction on preventing injury to the body during work periods will be conducted repeatedly for each phase of the work.

- Proper use of the nitrous oxide cylinders, regulators, and controls will be explained before use. The Safety Officer will supervise launch activities dealing with nitrous. Pressures between 600 and 900 psi will be maintained on the nitrous storage cylinders by surrounding them in thermal jackets in which ice water or warm water can be added as needed. Personnel will be at least 500 feet from the launch area while loading the nitrous into the rocket motor. This will prevent anyone from receiving frostbite from an uncontrolled leak. All operations for the nitrous will be done by electrical valves except for initial turn-on of the main cylinder valve during initial launch setup and after launch. A dump valve is part of the equipment in case of failure to launch. Once a rocket is launched or aborted, the main cylinder valve will have to be manually turned off.

### 3.d.4 Environmental concerns

We will police the area and remove all waste materials when we leave. The launch stand has a flame baffle on it to minimize danger of catching field on fire. We will be watching for any fire hazard at launch and during launch.

- Our procedure, if followed correctly, should pose little or no harm whatsoever to the environment.
- The blast plate will protect surrounding vegetation from the blast of ignition.
- Following every launch, the site will be cleaned up of any trash or debris from launch or recovery area.
- Only two or three people will be sent to recover the rocket, and they will be respectful of the surrounding environment.
- The oxidizing agent, nitrous oxide, will leak into the atmosphere in very small amounts, where it will quickly disperse. The amount is much too small to cause any amount of harm to the environment.
- The fuel, hydroxyterminated polybutadiene, is essentially only rubber. The spent fuel grain will be disposed of in a landfill, where it will eventually degrade into water and carbon dioxide.

## 3.e Payload Integration

### 3.e.1 Integration plan

The structure of the payload is shown in the following figures. The centerpiece of the payload is a 6" diameter plexi-glass plate. Four spring-loaded legs made of ABS plastic will be attached by hinges to the plate and connected by springs to the outside rim of the base plate. Four aluminum rods will be attached to the rim of the plate. They will be spaced evenly around the outside edge. The batteries and camera will sit on the plate.

The microcontroller will be placed above this plate. The sensors and the GPS will sit on the top platform.

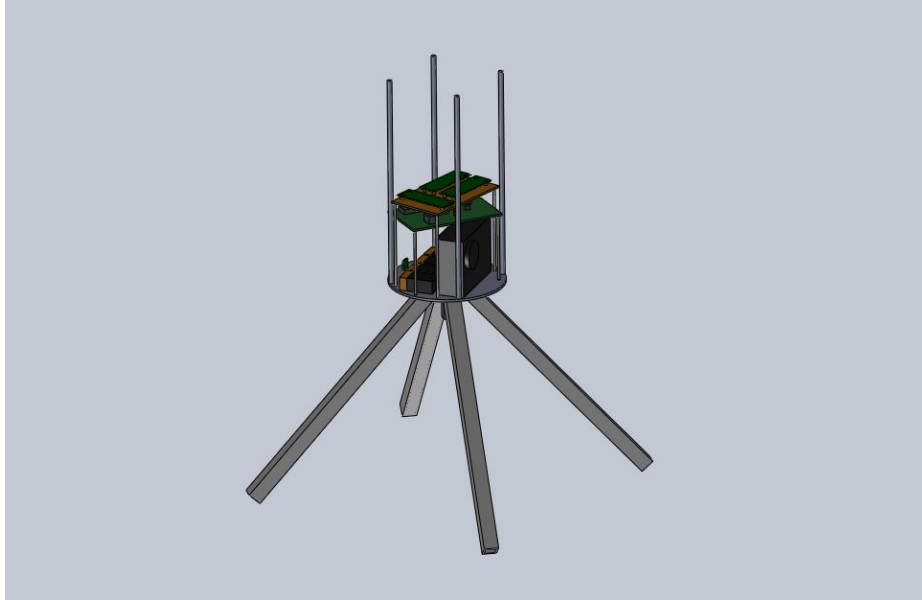

The payload will be positioned in the rocket as seen in the figures to follow. The bottom plate will be positioned inside the airframe near the connection of the main airframe with the nosecone. At 2,500 feet of elevation, the altimeter included in the payload will set off directional charges located at the end of the nosecone. The nosecone will hang from the main rocket by a shock cord. Without the nosecone, the payload will be free to fall from the rocket. This will cause the payload parachute to deploy. The fiberglass plate will protect the electronics in the payload from the blast. The rods on the top of the plate will prevent the electronics from bashing into the bulk plate further aft in the rocket.

The four legs will open upon separation from the rocket. These will be tucked inside the nosecone as shown in the following figures. A small hole will be drilled out of the side of the main airframe to allow the sensors to take accurate data. Also, the light sensitive sensors will be directed out of this hole.

### 3.e.2 Compatibility of elements

Since the payload body is made of standard high powered rocket parts used in virtually all rocket construction, all the materials are compatible. All the components of the electronic devices are on standard acrylic circuit boards and will be bolted into the payload and avionics bays. The plastic legs will be attached to the payload with ABS hinges. The top platform which contains the sensor circuits will be made of fiberglass. No gases, liquids or chemicals are part of the experiment.

### 3.e.3 Payload-housing integrity

The payload is housed within the fiberglass nosecone. This fiberglass outside structure is adequate to safely contain the payload. The sensors and circuitry are securely integrated into the payload structure as explain in other sections of the report.

### 3.e.4 Integration diagrams



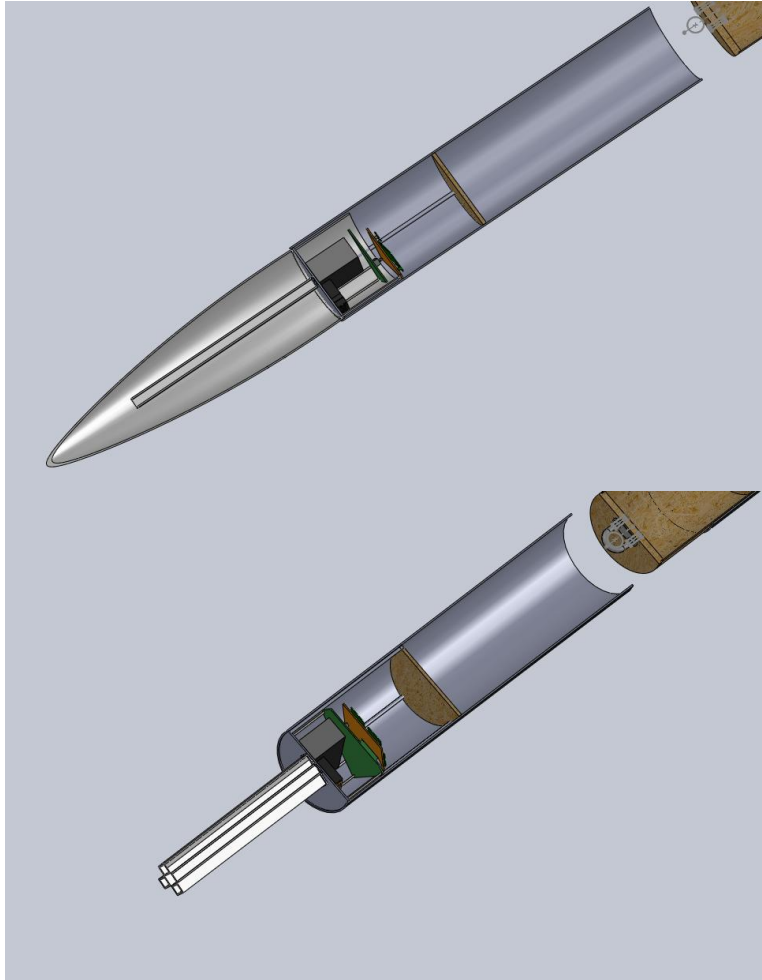

## 4. Payload Criteria

### 4.a Experiment Concept

#### 4.a.1 Creativity and originality

Due to our choice of selecting the SMD suggested payload, our payload is not particularly creative in its objectives. We feel our creativity is seen in the design of our actual payload pod. We chose to build a system that would release spring loaded legs after separation from the payload. We are also including a trigger on two feet of the payload to alert the system when it has landed.

#### 4.a.2 Uniqueness

Although finding data such as temperature in our atmosphere is not overly significant, finding the temperatures of the atmosphere for distant planets could prove to be very useful. This payload construction leads our design team to understand and build a system that could possibly be used in another atmosphere.

#### 4.a.3 Suitable level of challenge

This is a very appropriate project for college science and engineering students. CAD design, metal and electronic fabrication, tensile strength machines, presses and wind tunnels will be used. Also, Multisim is used for the design and to make sure it works, C++ is used to program the micro controller to function as desired, and knowledge in electronics and micro-controllers is applied. There will be lots of testing and calibration completed. Finally, reports such as this one will all help to enhance the education of participants with real-world hands-on activities.

## **4.b Science Value**

### **4.b.1 Payload objectives**

The payload division must complete the following objectives:

- Test and calibrate a pressure sensor that will record pressure at constant intervals over the rocket trajectory
- Test and calibrate a temperature sensor to be used to record temperature as a function of altitude
- Test and calibrate the relative humidity sensor to accurately measure the humidity in the air during the flight.
- Test and calibrate the UV radiation sensor to detect ultraviolet radiation from 200 to 1100 nm. The spectral response of the silicon photodiode detector is a good match to the spectrum of solar irradiance.
- The camera must take two pictures during descent and three after landing.

### **4.b.2 Mission success criteria**

Success will be measured by the ability of the payload to implement all of the sensors in a way that efficiently gathers the entire data.

The sensors excel by gathering the proper data and storing it in the computer memory.

That is, measurements taken at least every five seconds during descent and every 60 seconds after landing ending within 10 minutes after landing.

### **4.b.3 Experimental logic**

The idea of building this payload, is for the Science Mission Directorate's purpose. It is to build a high-powered rocket that would measure the irradiance of the Sun. Studies for each component in the payload have been studied to accomplish a better understanding of how they achieve goals.

Data will start recording once the payload is separated from the rest of the rocket, and will be stored in the memory. Once the payload reaches ground, the memory will be uploaded to a PC and data will be retrieved.

### **4.b.4 Test validity**

Due to the nature of the experiment, we expect all data to be valid. The test simply analyzes different atmospheric properties at different elevations in the atmosphere. The data is expected to be concise and the pressure readings are expected to be accurate and precise enough to provide a solid relationship between the other data readings and the altitude.

#### 4.b.5 Experiment process procedures

The payload section remains inactive until the rocket reaches apogee and the drogue parachute is released. At this time, the payload receives a signal to begin to take data. When the rocket has descended to 2500 feet, the nose cone is separated from the rocket and the payload is released which causes the spring loaded legs to be pushed to their final position. As the payload is separated, a timer is begun to send a signal to the camera to take pictures during the second half of descent. Upon landing, a trigger will be activated for the camera to take three more pictures and for data to be recorded at a new rate. The payload is located using the GPS system and data is retrieved through a USB port.

### 4.c Experiment Design of Payload

#### 4.c.1 Systems level review

The payload will consist of the pressure sensor, the temperature sensor, solar radiance/UV sensor, humidity sensor, the micro-controller, and the GPS. It will all be placed in a circuit board. The other circuit board will contain the camera's circuitry. Note that the UV sensor faces toward the outside.

-Temperature Subsystem -- the temperature transducer will be measured with a National Semiconductor LM50CIM3 transducer. This temperature transducer reads directly in Celsius degrees ( $10 \text{ mV}/^{\circ}\text{C}$ ). The nonlinearity is less than  $0.8^{\circ}\text{C}$  over its temperature range of  $-40^{\circ}\text{C}$  to  $+125^{\circ}\text{C}$ . The accuracy at  $25^{\circ}\text{C}$  is  $\pm 2\%$  of reading. It operates with any single polarity power supply delivering between 4.5 and 10 V. Its current drain is less than 130 mA.

-Pressure Subsystem -- the pressure transducer is an ASDX015A24R Honeywell device with a pressure measuring range of 0 to 15 psi and a burst pressure of 30 psi. It is powered by voltages in the range of 4.75 Vdc to 5.25 Vdc and has a current consumption of 6 mA. It will operate in the temperature range of  $-20^{\circ}\text{C}$  to  $105^{\circ}\text{C}$ . It survives 10 gram vibrations from 20 Hz to 2000 Hz and can survive a 100 g shock for 11 ms. Its lifetime is 1 million cycles minimum. The device is accurate to  $\pm 2\%$  H full scale.

-Solar Irradiance and UV Radiation Subsystem—an Osi-optoelectronics UDT-455 UV/LN component which is a photodiode-amplifier hybrid. While operating, the temperature range is  $0 - +70^{\circ}\text{C}$ . A spectral range can produce a response of 200nm to 1000nm. Supplied voltage usually is of  $\pm 15 \text{ V}$ , hence the quiescent current supplied will be of 0.9 mA.

-Relative Humidity Subsystem— a Honeywell HIH 4000-Series component will be used. With current operating at 200 microA and calibrated at 5Vdc,  $\pm 2\%$  RH(Relative Humidity), 0-100% RH non-condensing,  $25^{\circ}\text{C}$  is possible. The sensor is a laser trimmed thermo set polymer capacitive sensing element with on-chip integrated signal conditioning. The sensing element's multilayer construction provides excellent resistance to application hazards such as wetting, dust, dirt, oils, and common

environmental chemicals.

-Camera Subsystem -- a Vivitar Vivicam V7022 Graphite with 7.1 MP resolution and 4x digital zoom will be used. The flight computers will initialize the data capture at apogee and a pull switch will initialize the camera during descent. A 555 timer with a one-shot trigger will take the pictures after the payload has touched the ground.

-MicroController-- an EL™ is a high performance, C/C++ programmable controller based on a 40/80MHz 16-bit CPU. With a precision 2.5V reference, a sigma-delta 24-bit ADC (LTC2448, 5 KHz, 0-1.25V) offers 8 channel differential or 16 channel single-ended input channels. A 16-bit parallel ADC (AD7655, 0-5V) supports ultra high-speed (1 MHz conversion rate) analog signal acquisition. A 16-bit DAC(LTC2600) provides 8 analog output voltages (0-5V). The EL supports up to 2 GB mass storage Compact Flash cards with Windows compatible FAT file system support, allowing user easily transfer large amounts of data to or from a PC.

For the integration plan, refer to section 3.e.

Our design does meet all of the requirements asked for in our payload design. It contains the following:

- a pressure sensor that will record pressure at constant intervals over the rocket trajectory
- a temperature sensor to be used to record temperature as a function of altitude
- a relative humidity sensor to accurately measure the humidity in the air during the flight.
- a UV radiation sensor to detect ultraviolet radiation from 200 to 1100 nm. The spectral response of the silicon photodiode detector is a good match to the spectrum of solar irradiance.
- a camera that will take two pictures during descent and three after landing

#### 4.c.2 Precision and repeatability

Refer to section 4.c.1 for each system. Each instrument can be used more than one time and once the memory is recovered from the microprocessor the payload will be ready to fly.

#### 4.c.3 Practical application

For the creation of the payload, copious concepts of engineering were considered. The amount of voltage and current for each component had to work well with the functional requirements of another component. Due to the developed engineering thoughts, the payload should function accordingly.

#### 4.c.4 Flight performance predictions

The flight for the payload includes, launch, separation, and landing. Through the entire flight, all the components must stay in place to fulfill their purpose. Once it starts taking

data it will stop until it lands, and takes the pictures necessary. While still in the air, all of the sensors should have taken their respective measurements.

#### 4.c.5 Flight preparation procedures

To ensure that the payload is ready for flight, all of the voltages will be checked for each component. The GPS will be tested to prove that it can be indeed located through the output.

#### 4.c.6 Approach to workmanship

We will use mainly common parts that have stood the test of time. We will use some components of ABS plastic. These parts will be tested to make sure that they are acceptable. We will use fasteners with a very high factor of safety.

#### 4.c.7 Completed testing

- The GPS has been tested for functionality but we intend to also test the range before the competition launch.
- The temperature sensor has been tested, and has output the voltage necessary.
- The humidity sensor was tested, and one could observe the changing voltage.
- The UV sensor has not been tested.
- By testing the components separately and observing their outputs, being placed together, they should work as required.

### **4.d Payload Assembly**

#### 4.d.1 Payload assembly

See section 3.e.1 for payload assembly details.

#### 4.d.2 Compatibility simplicity

One concern for the payload is that it will make the rocket top heavy. The weight of the payload has been accounted for in the calculations, but these are only approximations and the actual weight might be higher. It might be necessary to find ways to lighten the payload.

#### 4.d.3 Structural integrity

The structure that will hold the payload is reliable due to the engineering concepts behind it. All of the electronic components have been well mounted to circuit boards, which are mounted into the structure. The batteries have been well placed and securely strapped.

#### 4.d.4 Construction quality

All of the construction and building have been taken place in laboratories designed for construction and building. Correct measurements were taken, as well as dimensions to fit in the rocket. All of the electronics are well mounted, with wires soldered to the board.

### **4.e Safety and Environment (Payload)**

#### 4.e.1 Safety officer

Edmond Wilson, Team Official, is the Safety Officer for the Harding Flying Bison 2010 USLI Rocket Team. He holds a NAR Level 2 Certification. Edmond Wilson's NAR Member Number is 86424.

#### 4.e.2 Updated failure mode analysis

Payload analysis of failure modes including proposed and completed mitigations:

- The payload fits completely inside a coupler on the rocket airframe.
- The payload has flown successfully previously with no failure. We will pay attention to the robustness of all electrical connections and be sure to use fresh batteries. The power does not come on until a g-switch initiates data recording upon lift-off.
- The science payload coupler is undergoing a series of tests to evaluate its structural integrity.

Launch operations analysis of failure modes including proposed and completed mitigations:

- Loss of some oxidizer after filling and before countdown and launch. This was due to a misunderstanding on our part of how far the launch team had to be from the rocket. We now are ready to deploy the rocket from a distance of over 318 feet and we know how to maintain the oxidizer tank full until the launch command is given.
- The nitrous oxidizer supply tank became too warm raising the pressure of nitrous to unacceptable levels for filling the rocket. We now have a procedure and hardware for maintaining the temperature of the nitrous supply tank to within a safe range.
- The fuel ignition system failed because the voltage through the electric matches was too low. We now add a 12 volt battery in series with the ignition unit to provide ample voltage and current for ignition

#### 4.e.3 Updated personnel hazards

Personnel hazards include:

- Injury to eyes or hands while machining payload or airframe parts. All will wear protective eyewear and instruction on preventing injury to the body during work periods will be conducted repeatedly for each phase of the work.
- Proper use of hand tools will be explained as needed for each process undertaken.
- Instruction on how to solder properly will be given when electrical circuits are being assembled.
- No chemicals are used in constructing or operating the payload. Only epoxy resin and spray acrylic paint is used in construction of airframe and payload.
- Protective gloves and face masks will be worn when working with these chemicals. The workplace will have the vent fan turned on to keep the fume levels to a minimum.
  
- All NAR regulations, MSDS safety sheets and tool and instrument manuals are

being collected together in one central location for workers to access during the construction and testing phase.

#### 4.e.4 Environmental concerns

-All payload work will be done in the laboratory under air-conditioning. No chemicals will be used. Other than brief smoke from the soldering process, there are no chemical hazards. Burns from inadvertently touch heated portion of soldering iron are virtually unknown and the small areas affected can easily be treated with burn ointment and band-aids.

-No electrical voltages high enough to cause shock are encountered with the equipment used.

-Our plan would pose no damage to the environment. We will use a flash arrestor on the bottom of our launch stand to protect the surrounding grass and weeds from catching on fire.

-A clean-up of the site after each launch will be conducted to remove trash and debris from the launch and recovery area.

-Only two to three people will enter the field to recover the rocket and they will be respectful of the crops in the launch field.

-The oxidizer is nitrous oxide. A small amount of this will be leaked to the atmosphere where it will be quickly dispersed. The amount will not contribute in any measurable way to the greenhouse effect.

## 5. Launch Operation Procedures

### 5.a Checklist

#### 5.a.1 Recovery preparation

All charges will be prepared and integrated by the avionics manager. He will be responsible for insuring the flight location transmitter is mounted securely in the avionics bay and that it is powered properly at launch. Another team member will use the folded antenna to track the rocket vehicle until it lands. These two recovery devices along with an avionics division member will be used to recover the rocket from the field, photograph it, inspect it briefly and bring it back to the launch site where the data from the science experiment and flight recorders can be downloaded onto a laptop computer.

#### 5.a.2 Motor preparation

The motor will be prepared as instructed by the motor preparation manual provided by Contrail Rockets. The manual is provided in the appendix.

#### 5.a.3 Igniter preparation

See section 5.a.2 for the igniter preparation instructions.

#### 5.a.4 Setup on launcher

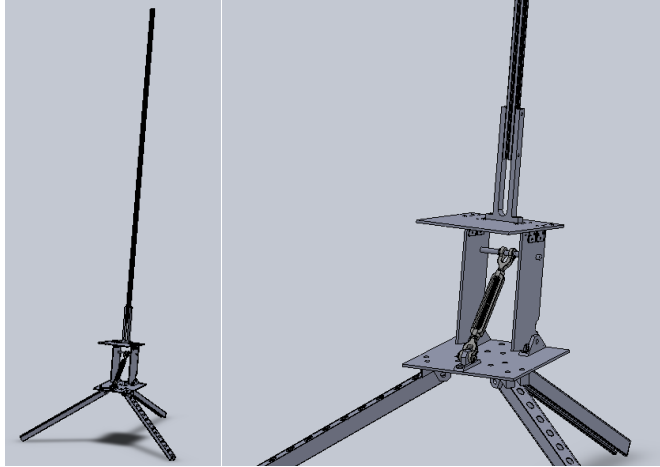

The previous figures show the rocket launch platform designed for launching high powered rockets. The launch rail can be loosened by removing a clevis pin so that it can be lowered horizontal for loading the rocket onto the rail. The system can be adjusted to provide a launch angle from near horizontal to vertical. A flash arrestor protects the ground below from fire starts. The rail is a one inch square aluminum T-Slotted Framing Rail, McMaster-Carr part number 47065T101. It has a 1/4th inch slot for the launch rails.

#### 5.a.5 Launch procedure

Two days prior to departure:

- Weigh nitrous tanks
- Charge all batteries - extras included.
- Organize and check tool box for supplies.
- Check supply list to make sure everything is accounted for

One day prior to departure:

- Clear departure time with all team members
- Send Vice President for Academic Affairs an Excuse Request for students
- Set everything required for the trip in one location and go through the supply list one-by-one to make sure everything needed is accounted for.

Departure Day

- Pick up van; load rocket and supplies; load students; travel to Huntsville
- Friday, 16 April 2010 – Launch Day -1
- Prep rocket motor
- Assemble and install payload

Launch Day

- Bring rocket and all necessary supplies to launch site.
- Perform final preparations and notify range officer when ready for launch
- Launch team carries rocket, launch stand, ignition system and nitrous system and ignition cable to launch area 500 ft from observation site
- Launch Manager performs final check on instruments and rocket
- Launch commences
- Recovery



## Return to hotel

### 5.a.6 Troubleshooting

The launch attempt on October 30th helped the team to get a feel for the types of problems that occur during a launch as several problems came up. The team was able to work through the problems, though, and fix them as they came up. The full scale launch in mid March will help to identify any other trouble points. The launch will give the launch team the experience necessary to carry out a successful launch in a professional, timely manner. It will also help to fill the procedure manual for the competition launch.

### 5.a.7 Post flight inspection

The post flight inspection is a valuable part of the launch process. Photographs will be taken of the landing site and the landed rocket. cursory inspection at the landing site will reveal whether or not the rocket fared well upon landing. Once the rocket is brought back to the launch area, a more detailed inspection will be conducted and the data from the experiment and the flight computers will be downloaded to a laptop computer.

## 5.b Safety and Quality Assurance

### 5.b.1 Demonstration of risks

See section 3.d.2 for an appropriate demonstration of risks.

### 5.b.2 Launch operations risk assessment

- Loss of some oxidizer after filling and before countdown and launch. This was due to a misunderstanding on our part of how far the launch team had to be from the rocket. We now are ready to deploy the rocket from a distance of over 318 feet and we know how to maintain the oxidizer tank full until the launch command is given.
- The nitrous oxidizer supply tank became too warm raising the pressure of nitrous to unacceptable levels for filling the rocket. We now have a procedure and hardware for maintaining the temperature of the nitrous supply tank to within a safe range.
- The fuel ignition system failed because the voltage through the electric matches was too low. We now add a 12 volt battery in series with the ignition unit to provide ample voltage and current for ignition.

### 5.b.3 Environmental concerns

- Our plan would pose no damage to the environment. We will use a flash arrestor on the bottom of our launch stand to protect the surrounding grass and weeds from catching on fire.
- A clean-up of the site after each launch will be conducted to remove trash and debris from the launch and recovery area.
- Only two to three people will enter the field to recover the rocket and they will be respectful of the crops in the launch field.
- The oxidizer is nitrous oxide. A small amount of this will be leaked to the atmosphere where it will be quickly dispersed. The amount will not contribute in any measurable way to the greenhouse effect.

### 5.b.4 Launch operations manager

Edmond Wilson, Team Official, is the Safety Officer for the Harding Flying Bison 2011 USLI Rocket Team. He holds a NAR Level 2 Certification.

## 6. Activity Plan

### 6.a Budget Plan

Division	Item	Company	Cost
Airframe	Couplers	Public Missile	\$26.40
Airframe	Centering Rings (6)	Public Missile	\$32.80
Airframe	Bulk Plates for Coupler(2)	Public Missile	\$12.50
Airframe	Airframe Tubes (2)	Public Missile	\$527.85
Airframe	Nose Cone	Public Missile	\$94.45
Airframe	Parachutes (3)	Public Missile	\$399.45
Airframe	Fins (4)	Public Missile	\$16.96
Airframe	Bulk Plates (3)	Public Missile	\$18.75
Airframe	Motor Tube	Public Missile	\$14.47
Airframe	Motor Retainer	AeroPak	\$52.00
Launch Operations	NOS	Airgas	<\$100.00
Launch Operations	Motor Hardware	Contrail	\$550.00
Launch Operations	Fuel Grain and Fittings	Contrail	\$95.00
Avionics	Altimeters (2)	Perfect Flight	\$199.90
Payload	Hardware	McMaster-Carr	<\$50.00
Payload	Power Supply	Duracell	\$8.00
Payload	Camera	Innovage	\$39.99
Payload	GPS		<\$200
Payload	Humidity Sensor	Honeywell	\$18.75
Payload	Temperature Sensor	National Semiconductor	\$1.11
Payload	Pressure Sensor	Honeywell	\$4.97
Payload	Ultraviolet radiation/ Solar Irradiance Sensor	Osiptoelectronics	<\$80.00
Payload	Microcontroller	Tern	\$129.99
Payload	Altimeter	Public Missile	\$129.95
		<b>OVERALL(Rocket):</b>	<b>\$2,803.29</b>

### 6.b Timeline

Task	Oct	Nov	Dec	Jan	Feb	Mar	Apr
Preliminary Design Report Due 19 Nov 2010		△					
Preliminary Design Review, PDR 6 Dec 2010			△				
Critical Design Report Due 24 Jan 2011				△			
Critical Design Review, CDR 2 Feb 2011					△		
Flight Readiness Report Due 21 Mar 2011						△	
Flight Readiness Review, FRR 28 Mar 2011							△

<b>USLI Launch Competition, 13-16 Apr 2011</b>	-----	-----	-----	-----	-----	-----	-----△
<b>Post Launch Assessment Review, PLAR, 9 May 2011</b>	-----	-----	-----	-----	-----	-----	-----
<b>Test Launch of Scale Model with Science Payload Prototype</b>	-----	-----△	-----	-----	-----	-----	-----
<b>Airframe Division</b>							
Final Design of Airframe	-----	-----	-----△	-----	-----	-----	-----
Order Materials for Airframe	-----	-----	-----△	-----	-----	-----	-----
Conduct Testing of Airframe and Airframe Components	-----	-----△	-----	-----	-----	-----	-----
<b>Build and Paint Airframe</b>	-----	-----	-----	-----	-----	-----	-----△
<b>Motor Division</b>							
Order Motor and Ignition Hardware and materials	-----	-----	-----△	-----	-----	-----	-----
Prepare Detailed Procedure for Motor Preparation and Flight	-----	-----	-----	-----	-----	-----△	-----
Prepare Safety Document for Motor, fuel and oxidizer transportation, flight preparation, ignition, flight, maintenance, stowage	-----	-----	-----	-----△	-----	-----	-----
<b>Static Testing of Rocket Motors</b>	-----	-----	-----	-----	-----	-----	-----△
<b>Science Payload Division</b>							
Design and Build Payload	-----	-----	-----△	-----	-----	-----	-----
Choose and Purchase Embedded Controller	-----	-----	-----△	-----	-----	-----	-----
<b>Integrate payload and Controller into Airframe</b>	-----	-----	-----	-----	-----	-----	-----△
Laboratory Test Payload	-----	-----	-----	-----	-----	-----	-----△
Prepare Operations Guide for Payload	-----	-----	-----	-----	-----	-----	-----△
<b>Avionics Division</b>							
Laboratory Test of Avionics Computers	-----	-----	-----	-----	-----	-----△	-----
<b>Install Flight Computers into Airframe</b>	-----	-----	-----	-----	-----	-----	-----△
<b>Launch Operations Division</b>							
Prepare Inventory of Materials, Equipment, Supplies	-----	-----	-----	-----	-----	-----△	-----
Order Needed Materials and Supplies	-----	-----	-----△	-----	-----	-----	-----
<b>Test Launch Rocket in Memphis</b>	-----	-----	-----	-----	-----	-----	-----△
<b>Prep and Launch Rocket at USLI Competition</b>	-----	-----	-----	-----	-----	-----	-----
<b>Outreach Division</b>							
Design and Implement Harding Flying Bison USLI Website	-----△	-----	-----	-----	-----	-----	-----
Outreach Project at area schools	-----	-----	-----	-----	-----	-----	-----△
Outreach Project with Girls Scouts and Boy Scouts	-----	-----	-----△	-----	-----	-----	-----
Carry Out and Record Publicity Projects	-----	-----	-----	-----	-----	-----	-----△
Seek External Funding	-----	-----	-----	-----△	-----	-----	-----
Recruit New Team Members	-----	-----	-----	-----	-----	-----	-----

### 6.c Educational Engagement

Four members of the rocket team will be speaking at the 2011 Arkansas Undergraduate Rocket Convention. Members of the team will also present the year's work at the Arkansas Space Grant Consortium event on April 22. The rocket team has been in close contact sponsoring a local high school team with the BalloonSAT project and is now working with a second high school team on a rocket competition. The outreach program has set final dates for all of the events to happen this year.

## **7. Conclusion**

We have now completed most of the construction of our airframe and payload and intend to finish within the week. We have confidence in our designs and will produce a full scale test flight before competition. In the weeks to come, we plan to complete construction and prepare all materials and procedures for competition. We intend to construct our payload as the first stage of construction.

## 8. Appendix

### Motor Preparation



## Contrail Rockets

### 75mm Hybrid Rocket Motor Reload

### Instruction Manual

Congratulations on your purchase of a Contrail Rockets 75mm Hybrid Reload. The supplied motor reload has been designed to operate in Contrail Rockets Hardware only. Before you begin assembly of this reload, please read through this manual and familiarize yourself with the steps. If you have any questions please contact Contrail Rockets.

#### Included With this Reload Package is:

Quantity	Item Name
1	Fuel Grain
5	Press-Lock Injectors (User Selected At Time of Purchase)
2	Igniters (24 Volt Resistor Type Igniter)
2	Nylon Fill Lines (User Selected At Time of Purchase)
1	Nylon Crossover Line (Short version of item above)
1	1/8 Inch Vent Line (Clear)
2	O-Rings (Size 230)
1	Instruction Manual

#### Not Included With this Reload Package is:

Synthetic Type Grease (Mobile 1 Synthetic or Similar Recommended)

Pyrodex Pellets (Muzzle Loading Pellets, Size 50/50 Recommended)

Deep Wall Socket Set

7/16 Inch Socket for 1/8, and 3/16 Inch Injectors

1/2 Inch Socket for 1/4 Inch Injectors

Allen Wrench (1/4 Inch Allen Wrench for 75mm Motors)

Good Pair of Cutters (Recommended: Radio Shack Coax Cable Cutters)

Roll of Electrical Tape

Cleaning Supplies for Post Flight Cleanup

## Motor Assembly Instructions



**Step 1:** Ensure that your motor hardware is clean and free from grease, oils, dirt and debris. Wipe the motor components with soap and water, to cut any residual grease from previous firings. Make sure you have all required tools and parts for motor assembly.

---



**Step 2:** Begin by installing all O-Rings onto Nozzle and Injector Baffle. All O-rings are Dash Number 230. O-Rings should be free from any cracks, burns or damage.



**Step 3:** Insert Press Lock Fittings into the Injector Face. A 1/8 Inch Fitting will always go in the center port. 1/8 inch Fittings are used for Slow Motors, 3/16 for Medium Motors and 1/4 Inch for Fast Motors. The Fittings should be tightened 1/2 turn past tight.

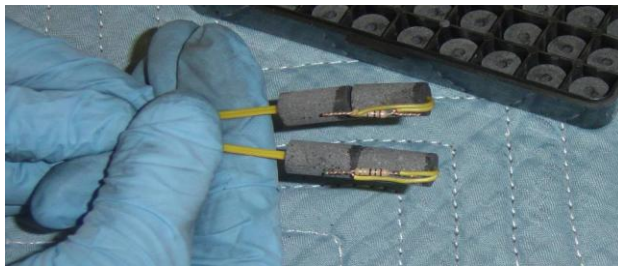

**Step 4: (Previous 4 Photo's):** Verify that you have the correct size and number of Pyrodex Pellets for your reload and then slide the igniter wire through the center hole of the pellet. Bend the resistor to the side of the powder pellet as shown. For 75mm motors we recommend (2) 50 Caliber/50 Grain Pyrodex Pellets. Ensure that you have placed the Resistor 90 Degrees away from the Nylon Line. This ensures proper ignition of the Pyrodex Pellet before the line bursts. The Pyrodex Pellets should be taped together and it is recommended that 2 wraps of Electrical tape should be sufficient over the entire igniter assembly to ensure ignition. Too Much



Electrical Tape can be a bad thing and cause the pellets to burn to fast. You only need enough tape to hold them to the line. Prior to Moving

onto the next step, ensure the lines are cut square and at a length of approximately  $\frac{3}{4}$  of an inch from the top of the Pyrodex Pellets.



---

**Step 5:** Insert the Fill lines w/ Pyrodex Pellets attached into the injector baffle on opposite sides. Ensure that the nylon lines go all the way into the press locks and go past the O-Ring Seal. You will feel it go past the O-ring and seat at the bottom of the fitting. You will now insert the clear vent line into the center fitting, and the short crossover line into the last 2 fittings. Ensure that all the lines are secure in the fittings prior to moving on.





**Step 6:** Using your roll of electrical tape, start taping around all 5 nylon lines. This will slightly pull the lines towards the center of the motor, and ensure the heat of the Pyrodex Pellets at ignition is kept near the lines to ensure a positive ignition. You will only need a single layer of tape over the line set to hold them together.

---



**Step 7:** Grease the Injector Baffle O-rings and slide the nitrous tank section of the motor onto the combustion chamber and insert the retention bolts. The bolts will require a ¼ inch hex head wrench.

---





**Step 8:** Grease the included fuel grain with a synthetic type grease (Mobile 1 or similar) and slide the fuel grain into the combustion chamber. Ensure that the fill lines, vent line and igniter wires are all drawn through the core of the grain. A thin coating of grease is all that is required.



**Step 9:** Grease the Nozzle O-rings and slide the nozzle into the combustion chamber. If you will be using a retaining ring on the nozzle, be sure to put this onto the nozzle prior to bolting it into the combustion chamber.

